

KAPPA-70



SPECIFICATIONS

ACOUSTIC & ELECTRICAL SPECIFICATIONS:

- * Nominal Impedance: 6-8 ohm
- * Recommended Amp Power: 20-200 W
- * Frequency Response: 45 Hz - 35 kHz (± 2 dB)
- * Sensitivity: 88 dB / 2,8V / 1 m
- * Crossover frequency: 350 HZ / 3,5 KHZ

SYSTEM COMPONENTS:

- * Cabinet: CLKAPPA70 (Not for sale)
- * Grille: GLKAPPA70 (2408680)
- * Grille: GLKAPPA70 (2408682)
- * Woofer: HT170IY4 170mm Woofer
30mm voice coil
- DC Resistance: 10,8 ohm
- * Midrange: M11MG-09-04 115mm Midrange
25mm voice coil

SYSTEM COMPONENTS: (cont'd)

- DC Resistance: 3,4 ohm
- * Tweeter: EMIT-R
- DC Resistance: 3,4 ohm
- * Crossover Network: NKAPPA70 (2708680)
- * Crossover Network: NKAPPA70 (2708681)

PHYSICAL SPECIFICATIONS:

- * Enclosure Dimensions (H.W.D): 36,2x10,2x10,4 In. D
(920x260x265mm D)
- * Shipping Weight: 46 lbs. (21 kg.)

WARRANTY INFORMATION:

- * Refer to the Warranty Statement packed with each product

PACKAGE

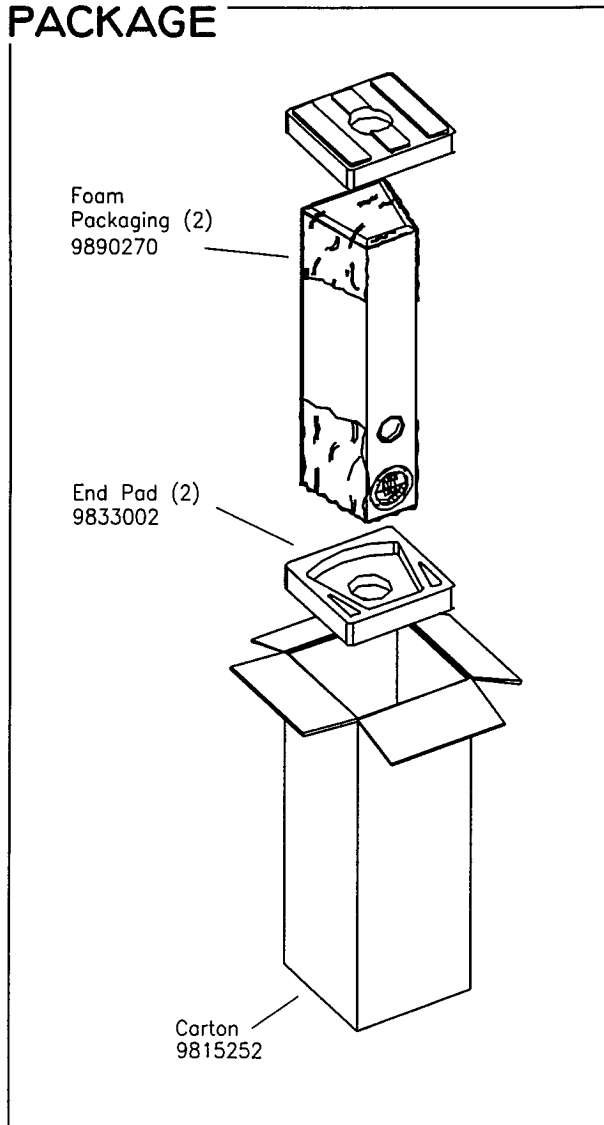

WIRING DIAGRAM

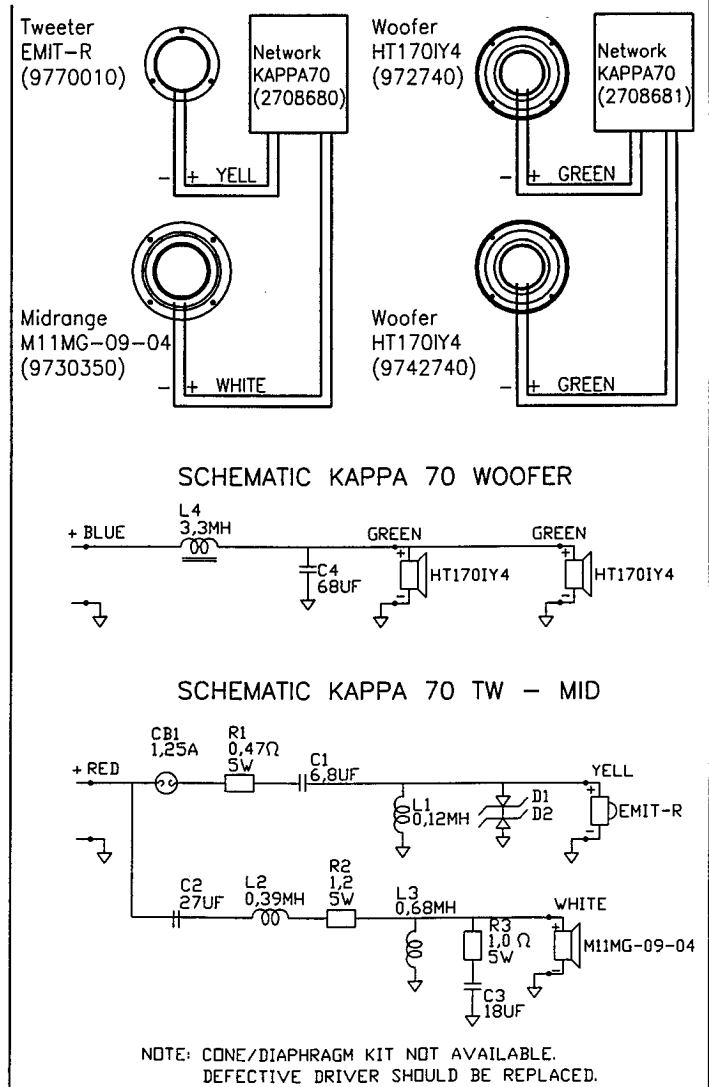

KAPPA-70

KAPPA-70

COMPONENT EXPLODED VIEW

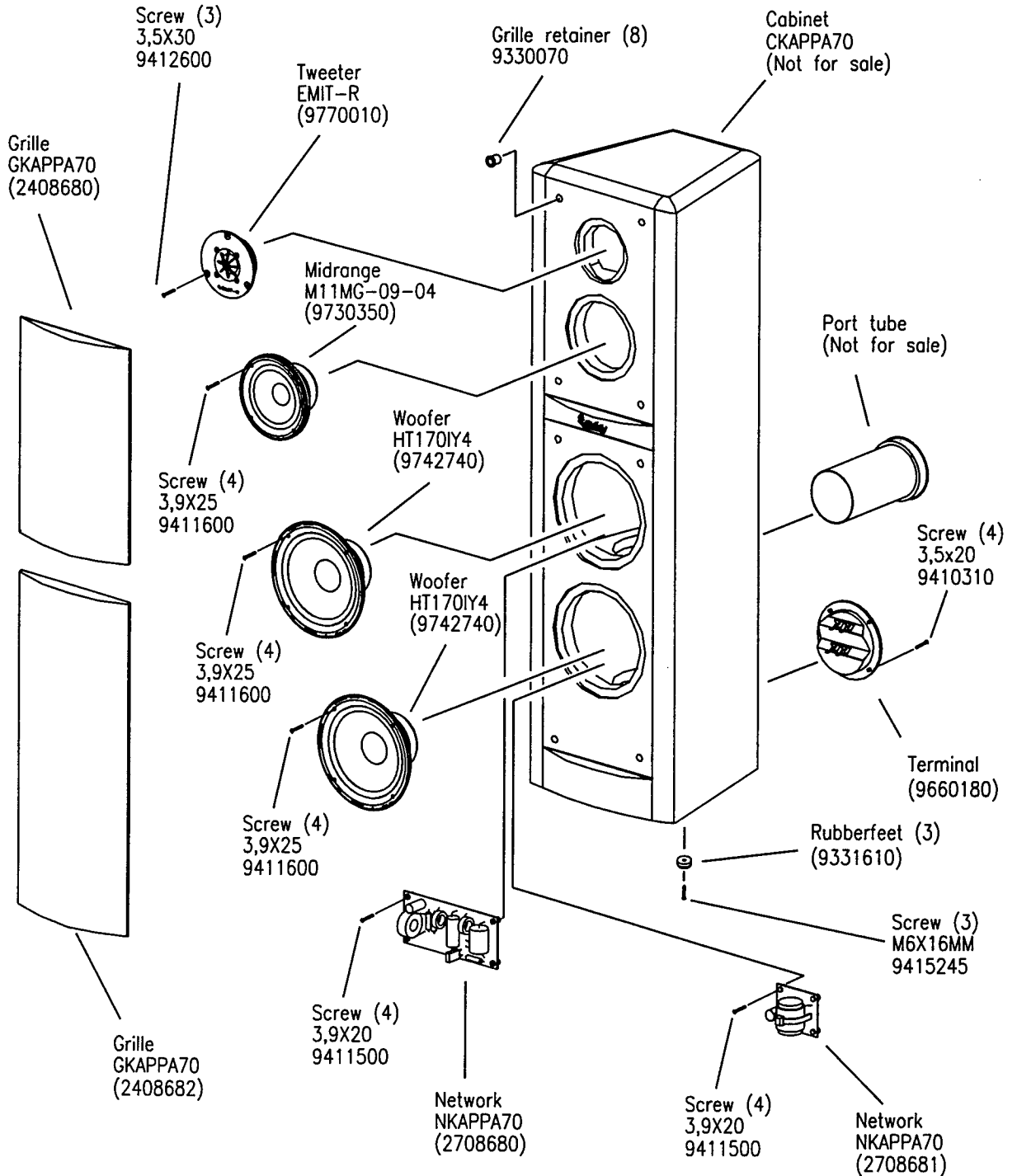

KAPPA-70